

Digital Overspeed Protection System with PROFIBUS -DP interface DOPS, DOPS AS, DOPS TS



- Systems DOPS and DOPS AS SIL3-certified
- PROFIBUS-DP Interface: (optional)
- Microcontroller based 3-channel measuring system
- High safety level due to password protection at each of the monitors
- Up to 6 limit values per channel
- Two current outputs per channel with zoom and dual current function, one of them electrically isolated
- Mutual comparison of pulses and output signals between all channels
- Redundant power supplies for monitors and backplane
- Self-test functions for electronic circuits and sensors
- Simplified fault detection by display messages in plaintext
- Electrical isolation of binary input and output signals
- Wiring by means of preformed cables and converters in the control cubicle
- RS 232 interface for input of parameters
- RS 485 interface for data exchange with the host computer
- Hot swap of boards during operation

Application:

The speed measurement and overspeed protection systems **DOPS** and **DOPS AS** serve the measurement of speeds and the protection of inadmissible overspeeds at rotating machines.

The **DOPS** systems in combination with safety shut-off valves are suitable to replace older mechanical overspeed protection systems.

With the consistent three channel design, starting with the signal detection via signal processing up to the evaluation of the measured speed, the system offers the maximum safety for the machines to be monitored.

Safety relevant limit values (e.g. overspeed limits) are submitted to the post-connected fail-safe technique.

Thus it can be ensured that beside operational safety, the protection function on a high level standard is met as well.

The integrated peak value memory permits reading out the maximum speed value that has occurred before the machine was switched off. This function provides important information for evaluating the mechanical machine load caused by the overspeed.

Alarm outputs and error messages are output as potential-free relay outputs and as short-circuit proof +24 V voltage outputs.

The alarm outputs, combined in 2 out of 3 logic, are also available as potential free relay contacts.

The system includes an extended fault detection function. The three speed sensors are continuously checked on operating within the permitted limits.

Moreover, the channels mutually check and supervise the output signals of each other. If the internal fault detection circuit detects an error, this will be indicated via the output contacts and shown on the display as plaintext.

By means of the the PROFIBUS DP interface the recorded data can be passed on to host computers.

By using prefabricated connection cables and screw terminals, the systems may be integrated economically in 19" cabinets.

System lines of the DOPS system:

For the measurement of speed and for the protection from overspeeds, **epro** offers three system variants.

System DOPS

This system offers a maximum in functionality and is certified according to SIL3 – DIN EN 61508 in combination with **epro** MMS eddy current measuring chains. It requires the following components:

- 3 x monitor **MMS 6350 (/DP)** (incl. firmware applic. no. 0) Profibus-interface (optional) or *alternatively*
- 3 x monitor **MMS 6350D (/DP)** (incl. firmware applic. no. 0) with speed display Profibus-interface (optional)

In addition:

- 1 x Backplane **MMS 6351/00**
- 1 x 19" frame **MMS 6352**
- 6 x screw terminals **MMS 6361**
- 6 x cable 0.5 m **MMS 6362** *alternatively* cable 3 m **MMS 6360**
- 1 configuration kit **MMS 6950**
- 3 x blind plate **BLE 008**, for the installation of monitors without display

When using this system line, there are additional combinations available via relay outputs beside the normal outputs of the alarms OUT1....OUT6 and the system supervision Channel Clear:

2 v 3 combination output OUT1
2 v 3 combination output OUT2
2 v 3 combination output OUT3
2 v 3 combination Channel Clear
1 v 3 combination Channel Clear

System DOPS AS

This system offers a special functionality for Astom applications and is certified according to SIL3 – DIN EN 61508 in combination with **epro** MMS eddy-current measuring chains. This system line requires the following components:

- 3 x monitor **MMS 6350 (/DP)** (incl. firmware appl. no. 2) Profibus interface: (optional) *alternatively*
- 3 x monitor **MMS 6350D (/DP)** (incl. firmware appl. no. 2) with speed display Profibus interface (optional)

In addition:

- 1 x Backplane **MMS 6351/10**
- 1 x 19" frame **MMS 6352**
- 6 x screw terminal **MMS 6361**
- 6 x cable 0.5 m **MMS 6362** *alternatively* cable 3 m **MMS 6360**
- 1 configuration kit **MMS 6950**
- 3 x blind plates **BLE 008**, for the installation of monitors without display

When using this system line, there are additional combinations available via relay outputs beside the normal outputs of the alarms OUT1....OUT6 and the system supervision Channel Clear:

2 v 3 combination output OUT2
2 v 3 combination output OUT4
OUT5 (= TRIP+CC) channel A
OUT5 (= TRIP+CC) channel B
OUT5 (= TRIP+CC) channel C

System DOPS TS

This system line is used to replace AEG-Turloop systems.

For the redesign on this system, the speed monitors MMG 1222 TS are removed from the slots and replaced by **MMS 6350+MMS 6353** each.

The old, existent Turloop frame remains in the rack, it is not necessary to change the wiring.

The following components are required:

- 3 x monitor **MMS 6350** (incl. firmware appl. no. 1)
- In addition:
- 3 x adapter **MMS 6353 TS**
- 1 configuration kit **MMS 6950**
- 1 set of blind plates **MMS 6354**

The DOPS TS system replaces the functions of the old Turloop system. With this system line not all functions of DOPS or DOPS AS are at disposal.

The DOPS TS system is not certified according to SIL3, DIN EN 61508.

The Profibus-interface is not available for system line DOPS TS.

Module supervision Sensor supervision

All three **DOPS** system lines offer the same extensive system supervision functions.

Reasons for module disturbances can be read out in detail via the communication interface or, at modules with a display, directly on the display.

This permits the technicians to recognize the reason for the fault immediately.

During the change from the error to the ok-state and after power-on of the module, all functions of the module are blocked for a delay time of 5 sec.

Depending on the backplane used or the installed firmware, the indication of faults or overspeeds is made via function-outputs and beside this via relay outputs with 2 out of 3 combinations of the alarm outputs.

The systems **DOPS** and **DOPS AS** offer the following supervision functions:

Pulse comparison

Analog comparison

Gap supervision
(Not for DOPS TS)

Sensor supervision:
(Short-circuit, interruption)

Sensor signal level

Sensor supply current

System supply voltages

System Watch-Dog

Internal temperature

Technical Data:

Signal input:

diff. input, non-reactive, open-circuit and short-circuit proof

Input voltage range:

0...30 V_{dc}

Input resistance:

>100 kOhm

Sensor signal output:

Front socket SENS.

decoupled, open circuit and short circuit proof, non-reactive, not calibrated, in phase with sensor signal

Voltage range: 0...4,1V_{pp}

Amplitude =

Sensor signal x (-0,15)

Accuracy:

±1% of full scale

Frequency range:

0...16 kHz (-3 dB) ±20 %

Permissible load resistance:

>1 MΩ

Internal resistance:

10 kOhm

Dynamic outputs:

Front socket pulses

The processed input pulses are output as TTL – pulses. open circuit and short-circuit proof, non-reactive

Nominal range:

TTL – level, 5 V_{SS}

Frequency range:

0 Hz...20 kHz

Permissible load resistance:

> 1 MΩ

Internal resistance:

5,1 kΩ

Pulse output

Pulse-C, Pulse-E

(Not available for DOPS TS)

The processed input pulses are output via potential-free opto-coupler outputs. The pulses are in phase with the input signal

Max. voltage (DC7):

+48 V_{dc} on collector

Max. current with C-E conducting:

Current limitation on 25 mA

Signal conditioning of the characteristic values:

Before processing by the processor, the input signals are standardized. The characteristic value is proportional to the speed.

Max. measuring range::

limited to 20 kHz by the max. input signal frequency

Max. speed:

65.535 rpm

Max. number of teeth:

255 (with N_{max} = 4700 rpm)

Current outputs –

Characteristical values:

Calculation of characteristical values and evaluation depend on the functions defined during the configuration

Current output 1 (Iout1):

0/4...20 mA / 20...4/0 mA electrically isolated

Measuring error:

±0,1% of full scale, 16 bit resolution

Current output (Iout2):

(Not available for DOPS TS)

0/4...20 mA / 20...4/0 mA with reference to internal GND, with feed back of this output signal for internal comparison of analog values

Accuracy:

±0,1% of full scale

16 Bit resolution

Speed zoom function:

programmable speed zoom function for each of the current outputs

Channel supervision and visualization:

Every channel permanently checks the signal of the speed sensor and compares signal pulses and current output with the signals of the other channels. Thus a maximum in safety can be ensured.

Faults are indicated with two green LEDs at the monitor front. Signalling of the channel supervision is carried out via opto-decoupled voltage outputs (function outputs).

Output „Channel Clear“

Operating mode open circuit or closed circuit mode freely selectable.

Voltage output

+24 V_{DC} = High state

0 V_{DC} = Low state

Max. Current

25 mA (current limitation)

Binary inputs:

Electrically separated from system ground, common reference point.

24 V - Voltage inputs

Signal level:

“Low”: 0...+3 V

“High”: +13...+32 V

Max. input voltage:

+/- 35 V

Input resistance: 6.8 kOhm

External blocking:

To disable the function-/ alarm outputs, e.g. for service and maintenance works etc.

Reset Latch:

To reset the latched function and alarm outputs

Test inputs:

For testing the monitoring functions with internally simulated test values.

Limit setting:

by configuration, depending on the assigned function. Visualization of the state with a yellow LED for each of the function-/ alarm outputs.

Binary outputs:

Altogether six function outputs with separate function or limit setting. The functions of the binary outputs as well as the switching characteristics are defined during configuration. The outputs are designed as 24V voltage outputs.

Voltage range binary outputs:

Supply of the binary outputs via backplane, electrically isolated from system ground, terminals DC3, DC4 and DC5 at the analog terminal blocks, decoupled via diodes.

Supply voltage range:

U_{out „High“} = +18...32 V

U_{out „Low“} = 0...+3.5 V

I_{out max} = 25 mA

Current consumption backplane: max. 280 mA

Relay outputs backplane:

(additional board)

2 out of 3 combinations of function outputs and Channel Clear

U_{max} = 48 V_{DC}, 20 V_{rms AC}

I_{max} = 4 A_{AC, DC}

max. cable cross-cut

at screw terminals: 1,5 mm²

Technical Data:

Communication interfaces

RS 232:

Front socket to connect a laptop for configuration and visualization

RS 485:

Bus interface for communication with external systems
No RS 485 bus connection at the Turloop backplane for DOPS TS.

SUB-D plug on front plate

for PROFIBUS-DP connection (optional)
not for DOPS TS

Sensor supply:

Decoupled and electrically isolated to the system voltages and the module supply voltage.
Open circuit and short-circuit proof

Supply voltage:

26,75 V_{DC}

Max. current:

38 mA

Residual ripple: < 20 mV_{SS}
(at nominal current 20 mA)

Module supply:

Two redundant inputs, decoupled via diodes, for nominal +24V with common ground.

Current consumption:

max. 250mA per card (with display)

Permissible voltage range:

18...32 V_{DC}
according to IEC 60654-2

Mechanical design of the printed circuit board:

Euro- Format (100 x 160 mm) according to DIN 41 494

Width:

with display: 14 TE
(approx. 71 mm)
without display: 6 TE
(approx. 30 mm)

Connector:

DIN 41 612, type F 48 M

Dimension of the total system:

DOPS, DOPS AS, DOPS TS
42 TE (approx. 213 mm)

Measuring modes:

The speed measurements are based on time measurements between pulses generated by the trigger wheel. There are two different measuring modes:

1. X * per rotation

With this measuring mode the period time of the pulses from the pulse wheel are measured within a variable time window of 5...10 ms and the speed calculated from it. Thus the measuring time with this mode is between 5...10 ms.

2. 1 * per rotation

The time for one revolution of the machine shaft is measured. From the result of this measurement the speed value is calculated.

The measuring time for this mode depends on the actual speed, e.g. 20 ms at 3000 rpm. The higher the speed of the machine, the shorter the measuring time.

This measuring mode is particularly suitable to measure the speed very exactly since mechanical influences caused by differences between the teeth of the pulse wheel are eliminated over a complete shaft revolution.

Programmable measuring parameters:

- Measuring range
- Speed zoom function:
- Gear transmission factor
- Analog difference
- Number of trigger wheel teeth
- Warning and alarm limits
- Principle of action
- Alarm functions
- Test value 1
- Test value 2
- Hysteresis
- Channel identification by means of KKS numbers or freely selectable designations
- Current outputs
- Current calibration
- Current suppression
- Current smoothing
- Duty cycle
- Stand still detection
- Gap limit values
- Trigger levels
- Channel clear limits
- Preferred direction of rotation
- Measuring mode
- Peak value latch
- Pulse comparison
- Ramp test

Comparison of measuring results:

The three **DOPS** monitors permanently compare their measurement results as well as the status information.

The following signals are compared with each other:

Signal Pulses

Each card permanently compares the own signal pulses with those of the two other cards. If an error is detected at this comparison, the card will indicate a pulse error. At the systems **DOPS** and **DOPS TS** the pulse comparison function can be deactivated.

Analog output (Iout2)

Each card permanently compares the own signal current output with those of the two other cards. If the configured analog difference is exceeded, the cards will indicate an analog error.

Limit value-/ function supervision:

The **MMS 6350** speed monitor provides altogether 6 function outputs. These function outputs may be used as alarm outputs as well as for indication of individual measuring states.

Moreover, the sixth function output offers the possibility to provide a digital signal for an external digital speed indicator or to output speed pulses.

The function outputs 1 to 6 can be assigned to the following functions:

- off
- > GW
- < GW
- > GW + latch
- < GW + latch
- Standstill
- Direction of rotation
- Dual current Out 1
- Dual current Out 2
- Pulse comparison
- Sensor fault
- GAP-warning
- Test value 1 active
- Test value 2 active
- Analog error
- > GW window
- < GW window

Beside this, function output 6 offers the following functions:

- Ext. display
- Pulse output

Description of the function outputs:

>GW

Speed limit, the output switches when this limit was exceeded. The output will be reset to its initial state after the measuring value has fallen below limit value minus hysteresis.

<GW

Speed limit, the output will switch when the speed has fallen below the limit value. The output will be reset to its initial state after the measuring value has exceeded the limit value plus hysteresis.

>GW + Latch

Same as >GW but with latching function.

<GW + Latch

Same as <GW but with latching function.

Standstill

Standstill of the machine is indicated via the function output.

Direction of rotation

The function output shows the direction of rotation.

Dual current Out 1

If current output 1 is operated as dual current output, the function output indicates the switching over from the lower to the upper current range.

Dual current Out 2

If current output 2 is operated as dual current output, the function output indicates the switching over from the lower to the upper current range.

Pulse comparison

In case of differences between the pulse outputs, this will be indicated via this function output.

Sensor fault

When the monitor recognizes a sensor fault, a warning will be indicated at standstill.

GAP- warning

If a tooth is just in front of the sensor head, the distance between sensor and tooth will be measured.

If the GAP voltage exceeds the window defined before, a warning message will be output. For the activation of this supervision function the trigger wheel has to be moved and the **DOPS** monitors must have received at least two pulses.

Test value 1 active

If the test-value is activated, this will be indicated.

Test value 2 active

If the test-value is activated, this will be indicated.

Analog error

When the monitor recognizes an analog error, a warning will be indicated.

> Limit window

If this limit-function is activated, the alarm output will be set active as long as the speed is outside the configurable range. Switching direction is increasing.

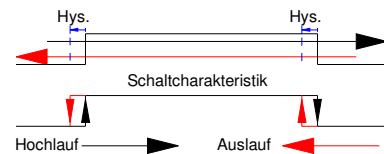

< Limit window

If this limit-function is activated, the alarm output will be set active as long as the speed is within a configurable range. The switching direction is decreasing.

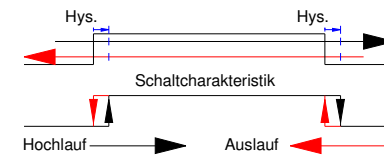

Ext. Display

(Only function output 6)

If this function has been chosen, an external display (MMG 418) to indicate the speed value may be connected to this output.

Pulse output

(Only function output 6)

When this function has been activated, digital pulses can be transmitted to external systems. The pulses of the trigger wheel are prepared, buffered and transmitted via this output. Each pulse at the signal input effects the output of one pulse at this output.

Transmission data Profibus DP:

There are 5 analog, 13 binary and 6 set/reset functions at disposal for the output via the optional Profibus DP.

The following functions are possible:

- Current speed
- Scaled speed
- Machine acceleration
- Maximum speed

- Direction of rotation
- Sensor break
- Sensor short-circuit
- Gap – value
- Switching state of function outputs 1 to 6
- Live signal to indicate subsequent electronic circuits that the function of the electronic is OK.

- Control inputs to reset individual latched messages and alarm outputs as well as three control inputs to activate the test values.

The baud rates of the Profibus DP data transmission is between 9600 and 12000 KBit/s.

Test functions:

To test the overspeed protection system and the signal lines during commissioning in a way as simple as possible, the speed monitors are equipped with a ramp test.

The ramp test can be started and controlled via the configuration software. The following parameters have to be entered for the test:

- Start speed
- End speed
- Ramp time
- Stop time
- Analog output active or not

The ramps can be programmed for increasing or decreasing runs.

After the ramp test was started, the monitor runs from the start speed up to the configured end speed. When reaching the defined speeds, the configured alarm limits will switch and the current outputs will follow the predefined speed values (if activated).

Safety logic:

In case the ramp test is activated when the machine is already running, the safety logic checks,

whether the machine speed is higher than the predefined speed of the ramp test. As long as the measured speed is higher than the simulated speed of the ramp test, the current outputs and the alarm outputs will reflect on the machine speed. When the simulated speed of the ramp test has exceeded the measured speed, the binary outputs and the analog output will show the state of the simulated ramp speed.

Dual current function:

On activating this function, a selectable range, e.g. 0...300 rpm (see fig. 1) is output as current range 0/4...20 mA.

When exceeding the limit of 300 rpm, the module switches over and will then output the complete measuring range as current range 0/4...20 mA.

The switching between the two current ranges is indicated via the relevant function output.

Fig. 1 shows an example for a dual current output with 0...300...3000 rpm on a current output 0...20 mA.

When using this function with a three channel **DOPS** system, only the electrically isolated current output I_{OUT1} should be used. Otherwise, analog error messages (with I_{OUT2}) could arise when switching between the ranges.

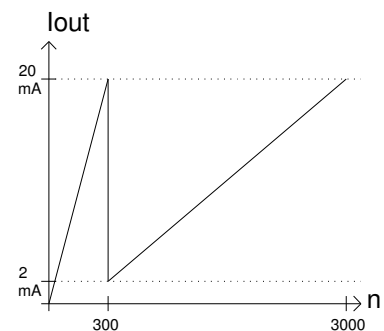

Fig. 1

Speed zoom function:

By means of this function, a certain speed range to be defined with start and end speed can be spread to the current output range 0/4...20 mA.

When using this function with a three channel **DOPS** system, only the electrically isolated current output I_{OUT1} should be used.

When using the current output I_{OUT2}, no analog comparison of the channels will be performed below the start value of the zoom range.

Fig. 2 shows an example for a speed zoom with a range of 2750 to 3250 rpm scaled on 4..20 mA.

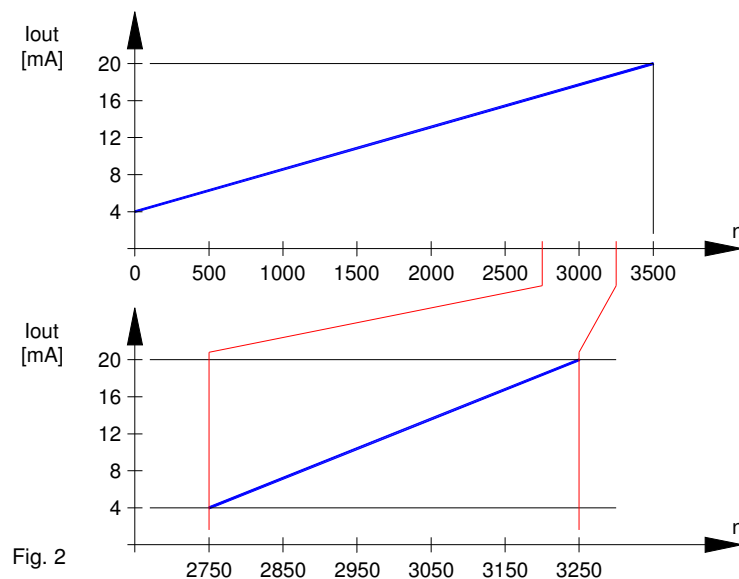

Fig. 2

Display- and operating elements at the module front:

One non-reactive output **SENS** (SMB socket):
 Range: 0...4,1 V_{pp}
 Load resistance: ≥10 kOhm
 Internal resistance: 10 kOhm

One non-reactive output **PULSE** (SMB socket):
 Range: 0...5 V
 Load resistance: ≥10 kOhm
 Internal resistance: 5,1 kOhm

MMS 6350D/DP
 8-digit alphanumerical LED-matrix, green

6 yellow LEDs:
 One LED for each of the function- /limit values

2 green LEDs:
 LED 1
 Supervision for the channel assigned to this card
 LED 2,3
 Indication of the state of the two adjacent system channels. If one of the adjacent channels fails (analog comparison), it will be indicated via the relevant LED.

1 Mini DIN diode socket:
 RS232 interface for connection of a computer for configuration and data interchange with the module.

1 SUB-D socket (9-pole).
 For connection of the Profibus DP system cable

Handle:
 To pull out and insert the module and for labelling purposes.

Power supply speed monitors:

Redundant supply input via two supply inputs, decoupled via diodes.

Current consumption:
 max. approx. 250 mA per card (with display and Profibus)

Other supply voltages can be realized with additional system power supplies.

Supply voltage:
 +18...24...32 VDC
 according to IEC 60654-2

Power consumption system
 max. 20 W
 (max. 840 mA at 24 V)

Environmental conditions:

Protection class:
 Module: IP 00 according to DIN 40050
 Front plate: IP21 according to DIN 40050

Climatic conditions:
 according to DIN 40040 class KTF
 Operating temperature range:
 0...+55°C (131°F)
 max. +65°C (149°F)

Reference temperature:
 +23°C (73,4°F)

Temperature range for storage and transport:
 -40...+70°C (-40...+158°F)

Permissible relative humidity:
 5...95%, non condensing

Permissible vibration:
 according to IEC- 68-2 part 6

Vibration amplitude:
 0.15 mm in range 10...55 Hz

Vibration acceleration:
 19.6 m/s² in range 55...150 Hz

Permissible shock:
 according to IEC- 68-2 part 29
 peak value of acceleration:
 98 m/s²
 nominal shock duration:
 16 ms

EMC resistance:
 according to EN 50081-1/EN 50082-2

Requirements on configuration PC:

Configuration of modules is made via the RS 232 interface on the module front or via the RS 485 bus by means of a computer (laptop) with the following minimum specifications:

Processor:
 Pentium II, 266 MHz or better

Interfaces:
 One free RS 232 interface

Capacity of hard disk:
 min. 50 MB

Required working memory:
 min. 500 MB (in accordance with request of the operating system)

Operating system:
 Windows® 2000 and XP

Backplane MMS 6351/x0:

Screw terminal adapter MMS 6361:

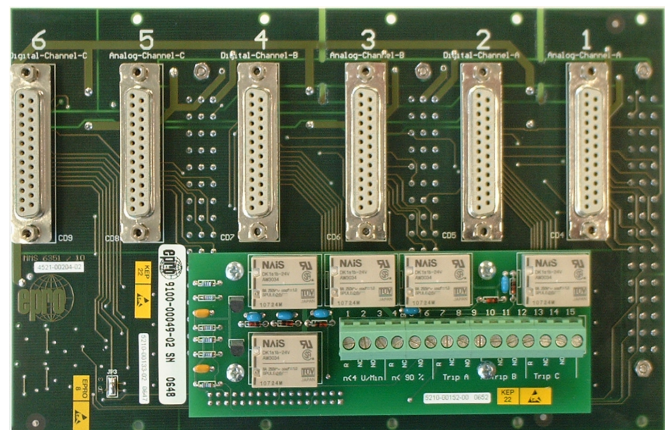
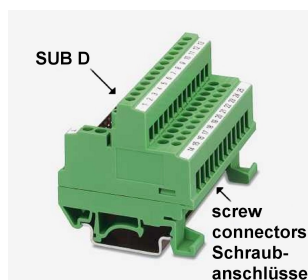

Trigger wheel and mounting angle of sensors:

The more precise the trigger wheel has been fabricated, the more exact the speed measurement can be performed.

A tooth depth of at least 1 mm has proved to be advantageous when using the PR 6423/.. sensor with a measuring range of ± 1 mm. With this tooth depth a continuous distance supervision (Channel Clear) of the sensor is possible.

The mounting angles of the sensors result from the geometrical specification of the trigger wheel and the minimum distances between the sensors.

These angles are important for a correct detection of the signal pulses and to detect the direction of rotation.

Requirements on the trigger wheel:

- Tooth form Rectangle
- Tooth depth ≥ 1 mm
- Tooth width $\geq \varnothing$ Sensor

- Module of trigger wheel **

PR 6422	≥ 2
PR 6423	≥ 3
PR 9376	≥ 1

- Distance

Sensor - tooth	$\approx 0.5 \dots 1$ mm
----------------	--------------------------
- Radial run out: < 0.05 mm

** Module = $P[\text{mm}] / \pi$

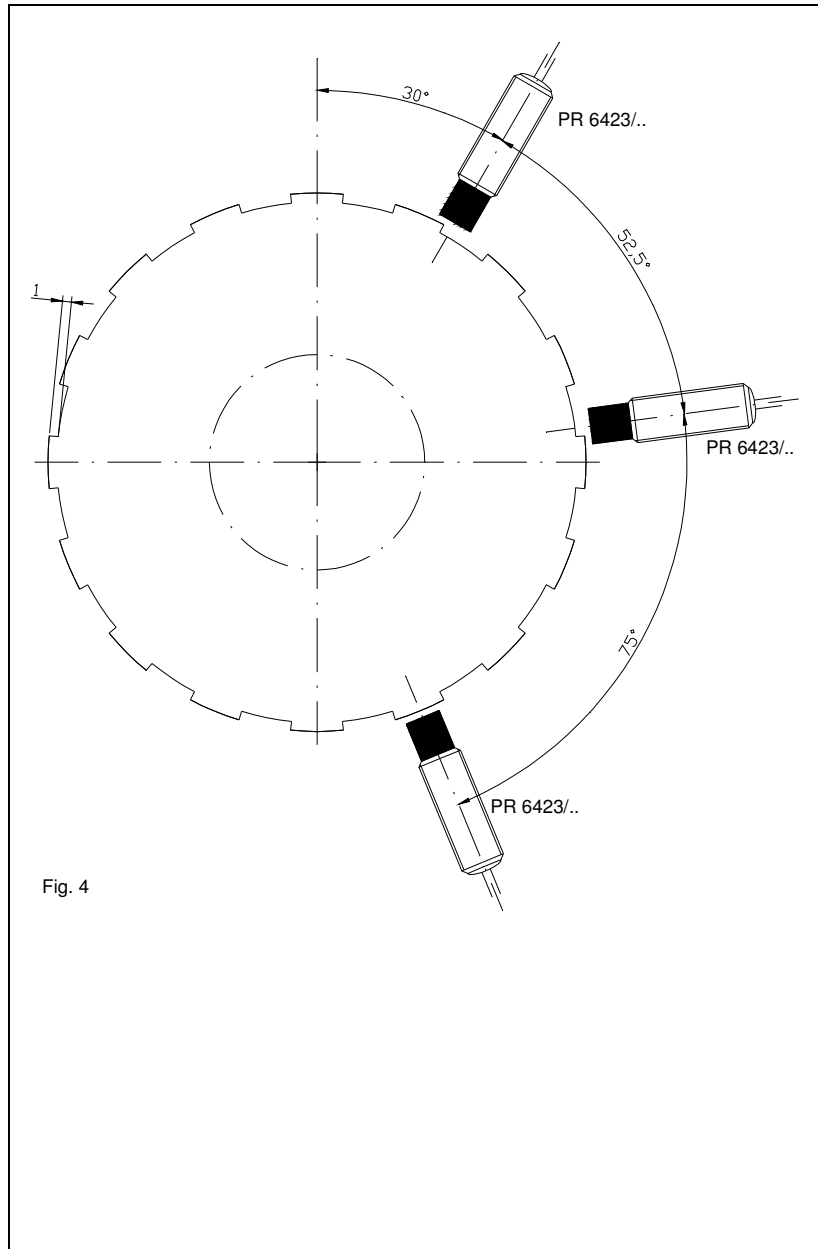

Order numbers:

MMS 6350/DP	Speed measurement card with PROFIBUS DP.....	9100 – 00065
MMS 6350D/DP	Speed monitor with digital display and PROFIBUS DP.....	9100 – 00066
MMS 6351/00	Backplane for System DOPS	9100 – 00047
MMS 6351/10	Backplane for System DOPS AS	9100 – 00049
MMS 6352	19" rack / 3HE	9100 – 00053
MMS 6360	Connection cable 25 pol. SUB D 3 m.....	9510 – 00006
MMS 6362	Connection cable 25 pol. SUB D 0,5 m.....	9510 – 00015
MMS 6363	Profibus connection cable 4 m	9510 – 00024
MMS 6361	Screw terminal 25 pol. SUB D.....	9100 – 00052
MMS 6950	Configuration Kit.....	9510 – 00005
MMS 6354	Set of blind plates	9501 – 00005
BLE 008	Blind plate 8 TE	9501 – 00003

© epro GmbH
 Jöbkesweg 3 D-48599 Gronau
 Tel. +49 (0) 2562/709-245
 Fax +49 (0) 2562/709-255

Further information:
 Internet: www.epro.de
 E-Mail: info@epro.de

epro